

DISTRIBUTION BROCHURE

**AWESOME<sup>®</sup>**



**DRIVEN BY PERFORMANCE**

[www.awesomegti.com](http://www.awesomegti.com)

# AWESOME

## **WELCOME**

**Awesome Ltd** was established back in 1989 as a result of a hobby that ran away with itself. The word 'Awesome' was aptly chosen when the American cartoon series The Simpsons reached our shores at the same time.

Customers over the years have discovered that Awesome is always striving to be the very best performance parts, tuning and servicing specialist around – constantly exceeding expectations of anyone who deals with us in person, digitally or over the phone.

Awesome is a leader in the supply of performance parts from several manufacturers, many of them exclusively, not only in the UK but globally. Although we are a specialist in VAG-Group vehicles, many of the brands we offer cater for all marques. The full catalogue for any brand we offer is available to you upon request. As our business continues to grow, we will continue to invest in the areas that support our customers most effectively.

With an experienced and dedicated team centred around the supply, distribution and support of performance car parts, Awesome is a strong, reliable partner to help support you and your business.

## **DRIVEN BY PERFORMANCE**



## OUR FACILITIES

In June 2023, Awesome officially opened its doors to its all-new, cutting-edge headquarters, located next door to its previous site in Northbank Industrial Estate, Irlam (which the company has retained to become the official base for sister brands Vagbremtechnic and Performance M).

This mammoth 30,000sq ft complex undoubtedly pushes car workshop/dyno cell/parts distribution facilities to a whole new level in the UK and far beyond.



## RECEPTION AREA

A gleaming reception area with a unique high-polish resin floor houses customer seating and workstation areas, as well as a fully-fledged coffee bar (complete with Awesome-branded coffee) for staff and customers to catch up in a comfortable environment. Bi-fold doors also mean that various development and race cars are regularly shown off within the reception area itself.

## WORKSHOP

A glass wall allows customers in reception a detailed insight into the core of the new premises: the vast workshop space, which plays host to six 3.5-tonne two-post ramps, a 5.5-tonne commercial lift and a scissor lift within the four-wheel alignment area. It's no surprise that the workshop is also a spotless space, with touches such as integrated toolboxes flanking the outer walls continuing that streamlined, minimal Awesome branding.



◀ **SCAN HERE**  
**TO FLY AROUND OUR HQ!**

// Not only did I want our new headquarters to be the best it possibly could for both staff and customers, but I also wanted to make sure I put my own stamp on the company. With this new setup, I want to inspire others in our amazing industry. //

**Mark Ash,**  
Managing Director

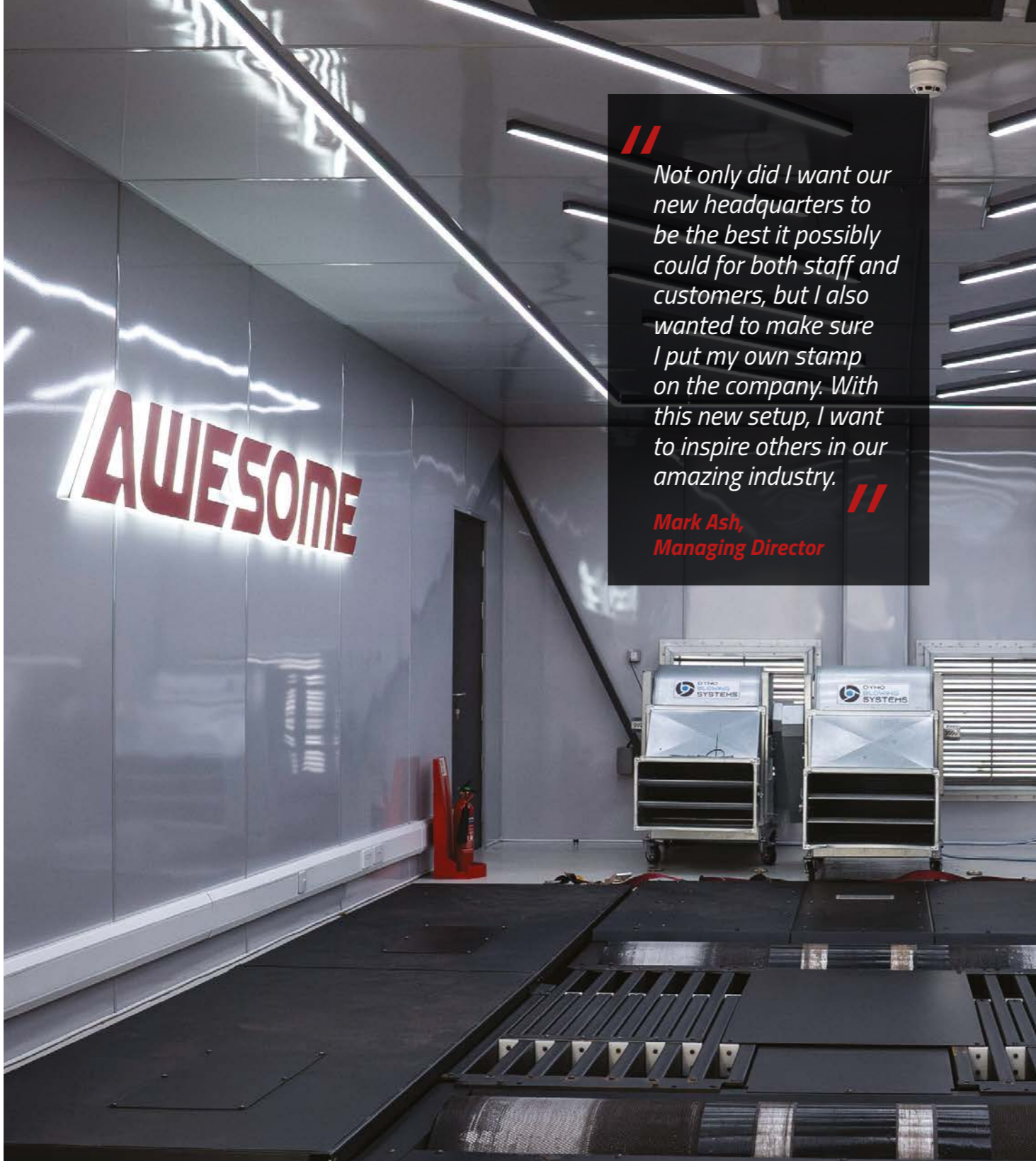

**DYNO CELL**

The dyno cell is arguably the main highlight of the workshop area – a fully-bespoke room that features a Dynojet 4WD link dynamometer, custom LED lighting as well as no less than six fans that are presented as an art piece in themselves.

Adjacent to the dyno cell is the dyno lounge – undoubtedly the most prestigious place to watch your car on a rolling road for hundreds of miles around. Not only are customers supplied with headsets to talk to their personal technician from this plush, comfortable setting, but the switchable frosted glass acts as the cherry on the top of this unforgettable experience.

**STAFF AREAS & OFFICES**

It goes without saying that Awesome staff are treated just as well as customers in their new working home, with spacious offices (all with a nice vantage point of the workshop, of course) and even a fully kitted-out gym making it the best working environment possible.

Within the staff areas, there's also numerous meeting and training rooms for the likes of development days with Awesome's vast network of dealers and resellers.





**EXCLUSIVE UK DISTRIBUTORS FOR:**





TRADE DISTRIBUTORS FOR:



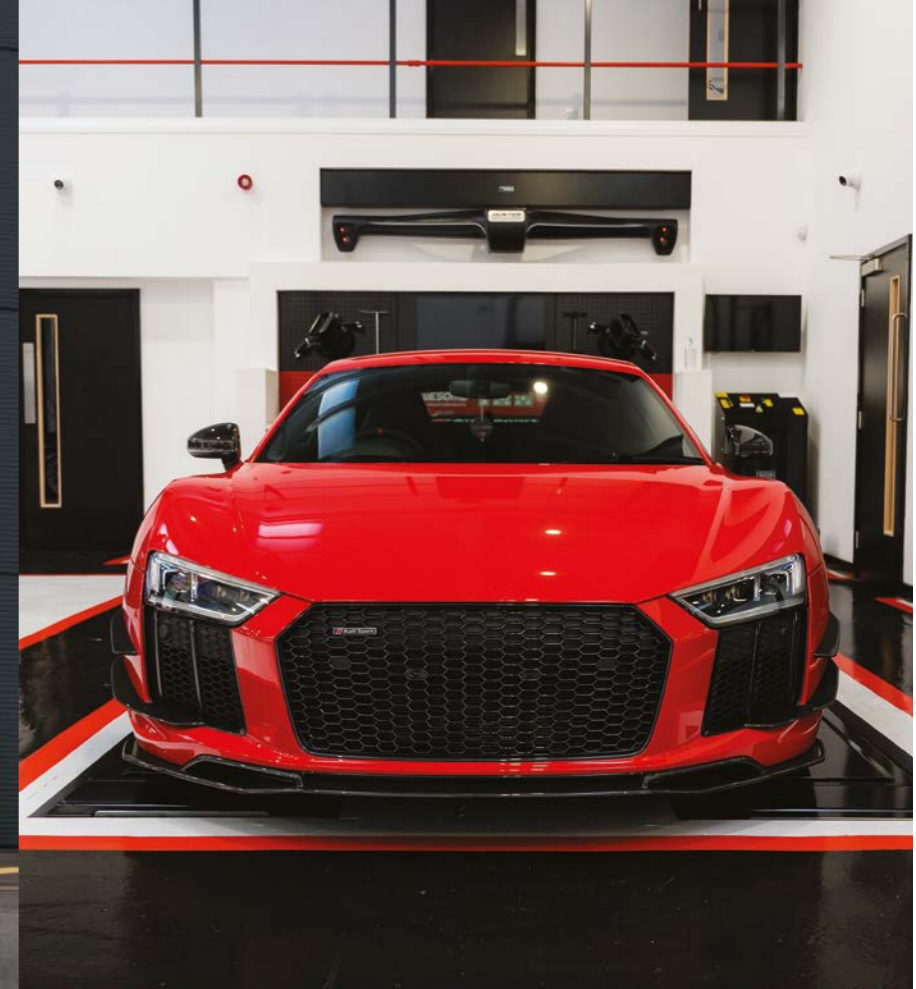

### THE GO-TO DISTRIBUTOR

Did you know Awesome has a large portfolio of exclusive aftermarket brands we are able to offer to trade?

Over many years, Awesome has built relationships becoming exclusive distributors for many brands as well as gaining distributor status for many others. This brochure is to highlight exactly what brands we have to offer business-to-business.

### UNRIVALLED STOCK LEVELS

In recent years Awesome has invested in excess of £600,000 stocking popular fast moving items. This is to ensure we support our network of dealers to the best of our ability. We will continue to invest in our stock as our business continues to grow.



### TRADE ENQUIRIES

Awesome has a well-established, knowledgeable sales team to support you as well as having an experienced workshop we can utilise should you need any technical assistance.

**For all trade enquiries:**

Phone: 0161 776 0777

Email: [sales@awesomegti.com](mailto:sales@awesomegti.com)





MORE INFO:



RacingLine Performance has been developing high-quality performance upgrades for over two decades alongside its 'works' motorsport programmes – firmly establishing itself as the brand of choice for enthusiast VWG owners around the world. Combining extensive experience and development, it presents the ultimate range of Performance Parts, developed in perfect harmony with its 'Racingline Performance Software'. In other words, the complete tuning solution.



Stage 3 Big Brake Kit

R360 Alloy Wheels



Performance Lowering Spring Kit



R600 Cold Air Intake



Tracksport 2-Way Adjustable Coilovers





# RACINGLINE™ PERFORMANCE SOFTWARE

MORE INFO: ➔



RacingLine Performance Software is simply the most effective modification you can make to a modern turbocharged engine. Instead of simply overwriting the existing software, RacingLine Performance Software takes the manufacturers' philosophy and create a complete new calibration designed from scratch, exclusively for each model – all working in perfect harmony with its world-renowned Performance Parts range.



Power Control Module



Power Delivery Module



## Stage 1 & 2 ECU Tuning

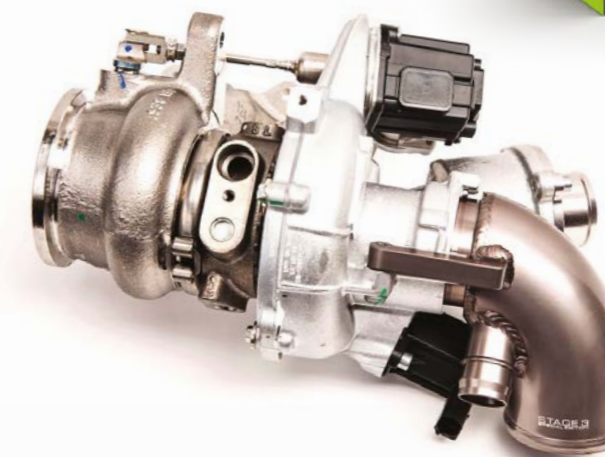

## Stage 3 ECU Software & Hardware Tuning Packages

## TCU Software Upgrades



## Engine/Gearbox Tuning Package Deal





# 034 MOTORSPORT

MORE INFO:



034Motorsport was founded in 2005 with a passion for bringing motorsport-quality performance upgrades and tuning solutions to Audi and Volkswagen vehicles. The company has since evolved and grown to meet the expanding needs of enthusiasts, but the underlying passion for innovation, performance, and quality remains. Dedicated to providing customers with only the best performance products, tuning, and service for their Audi or Volkswagen.



Dynamic+ Lowering Springs



Lower Control Arms



Billet Dogbone Mount



Carbon Fibre Air Intake





Forged Carbon Fibre Rear Diffuser



**MORE INFO:**  
(for non-VW Audi-Group marques,  
please contact us directly)



ECS Tuning has a long and celebrated history supporting the European car community. From its beginnings as a family-operated service shop, ECS Tuning has become the leading distributor of genuine, aftermarket, and performance parts for your Audi, BMW, Mercedes Benz, MINI, Porsche, or Volkswagen – all while remaining fully enthusiast-operated.



Carbon Fibre Paddle Shifters



'R8' Ignition Coil Pack Set



Kohlefaser Luft-Technik Intake System



**MORE INFO:**  
(for non-VW Audi-Group marques,  
please contact us directly)



APR's sole mission is to engineer only the highest quality tuning solutions for Volkswagen, Audi, Seat, Skoda, and Porsche vehicles, ensuring the enthusiast the ultimate driving experience while consistently providing the enthusiast the ultimate in customer care and support. Range-topping hardware and software upgrades for your car!

**Cat-Back Exhaust System**



**6-Piston Big Brake Kit**



**Direct-Fit Turbocharger**



**Ignition Coil Pack - R8 Style**



**A01 Flow-Formed Alloy Wheel**

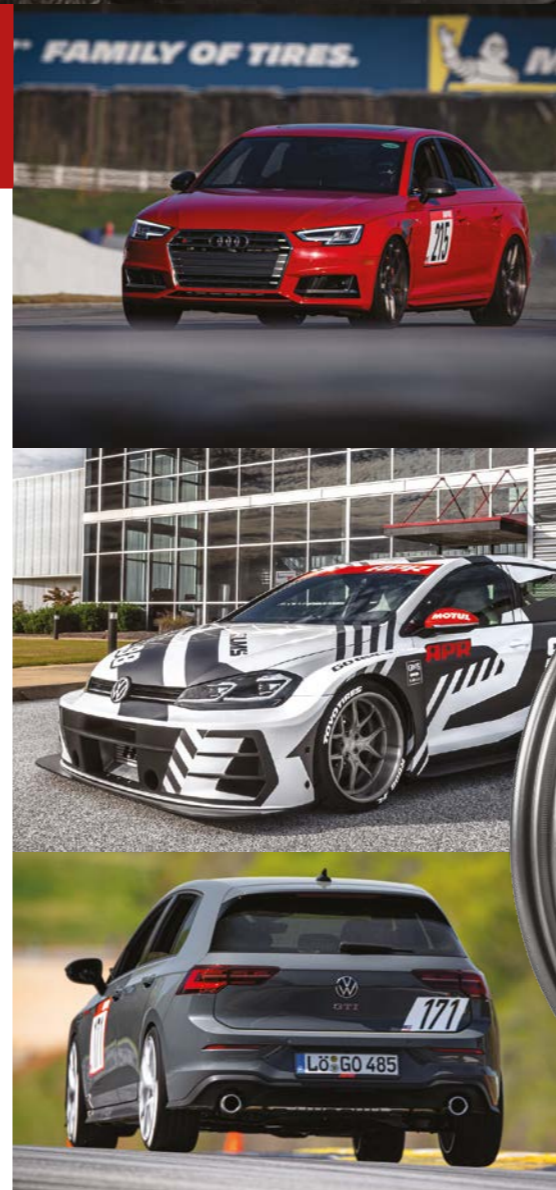



# APR SOFTWARE

**MORE INFO:**  
(for non-VW Audi-Group marques,  
please contact us directly)



APR's range of ECU and TCU software upgrades are meticulously developed in the firm's USA headquarters by a team of talented, OEM-experienced engineers. The result is high performance, with the quality and refinement you'd expect from a factory vehicle.





Hi-Flow Turbo Discharge Pipe

# NEUSPEED®

**MORE INFO:**  
(for non-VW Audi-Group marques, please contact us directly)



Automotive Performance Systems Inc. (APS) and its **NEUSPEED®** and Neumann Distributing divisions are the number-one source for aftermarket performance products, carrying a large inventory of parts, with unrivalled customer service and the most knowledgeable support team in the industry.



P-Flo Air Intake Kit



Flow-Formed Alloy Wheels



Rear Anti-Roll Bar



Short Shift Kit



**MORE INFO:**  
(for non-VW Audi-Group marques,  
please contact us directly)



In a world where performance, efficiency, and value for money are paramount, **Leyo Motorsport** brings the latest technology for the ultimate modifications to the Volkswagen Automotive Group. It aims at closing the gap between the race culture and street performance through high-end and well-researched modifications. Leyo Motorsport uses the highest quality materials to create products that allow you to push the limits of tuning to create your own street monster.



**Charge Pipe Kit**

**Cold Air Kit**

**Oil Catch Can Kit**

**Billet Climatronic Rings**





AirGate Carbon Fibre Intake Kit



Coldfront Intercooler



MORE INFO: 



From award-winning handcrafted performance exhausts to track-tested carbon fibre intakes and performance intercoolers, **AWE Tuning** innovates, designs and manufactures, with a state-of-the-art headquarters based outside of Philadelphia, Pennsylvania. Since 1991, AWE's team of researchers, engineers, innovators, and drivers have introduced premium performance upgrades for some of the finest automobiles in the world.

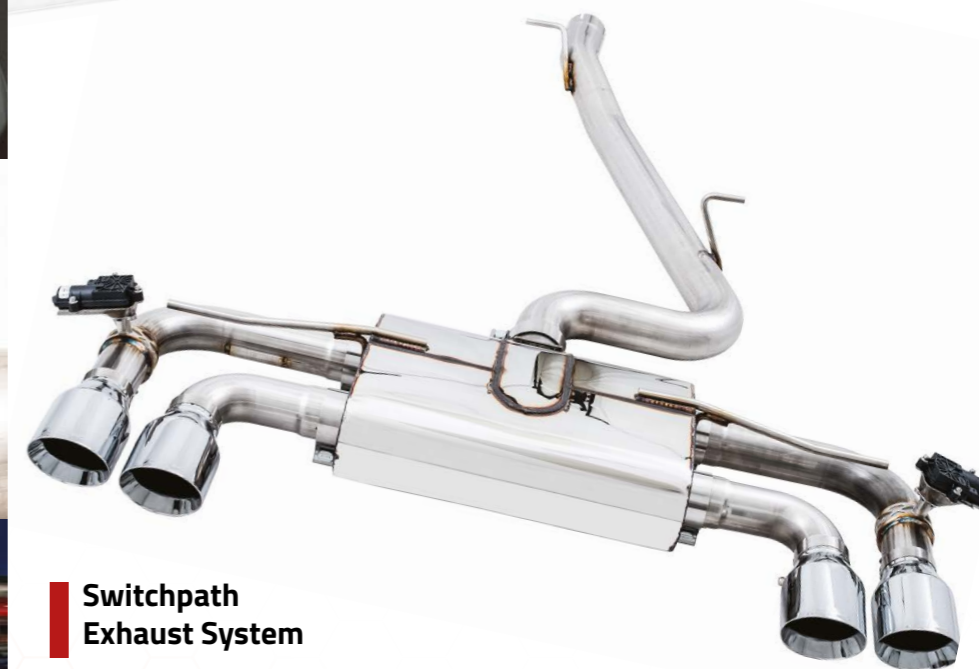
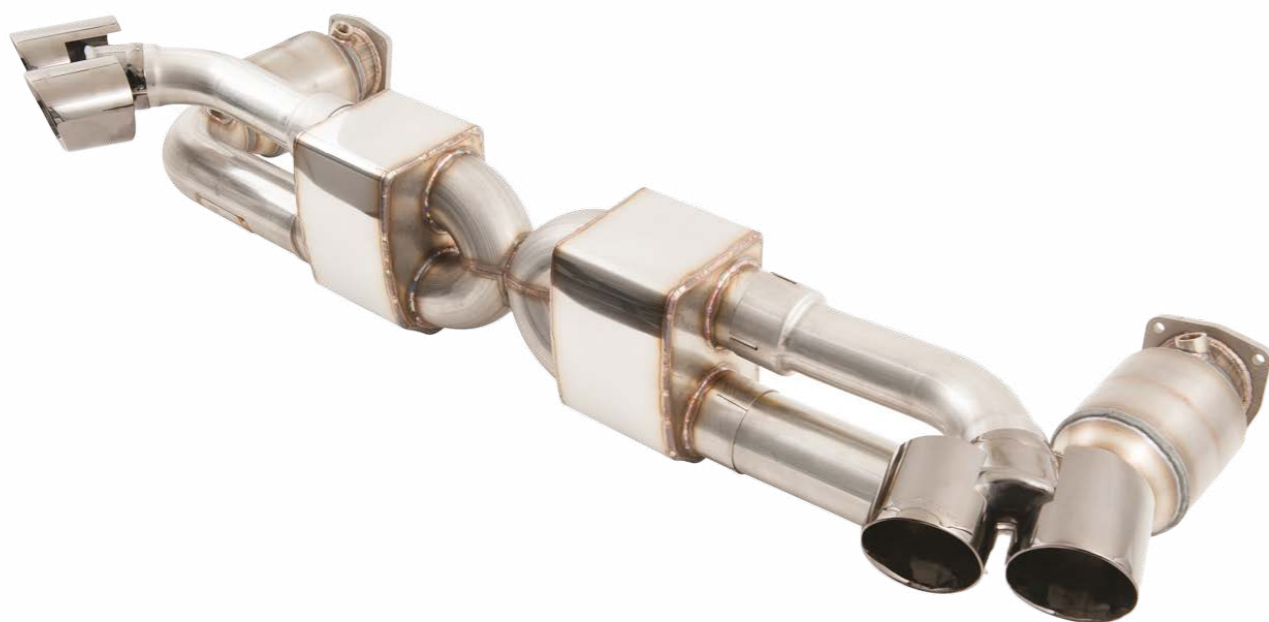

Switchpath Exhaust System





Race Chip GTS 5

# RACE CHIP

MORE INFO: ➔



In 2008, Manuel Götz made his passion for automobiles his career: **RaceChip** was born. Since then, a continuously growing team of vehicle enthusiasts and engineering fans have worked with passion to develop products and forge ahead with new innovations that give you the best driving experience possible. Power, dynamism and innovation are RaceChip's priorities, illustrated in every item of software and hardware created – now available for over 3000 vehicles.

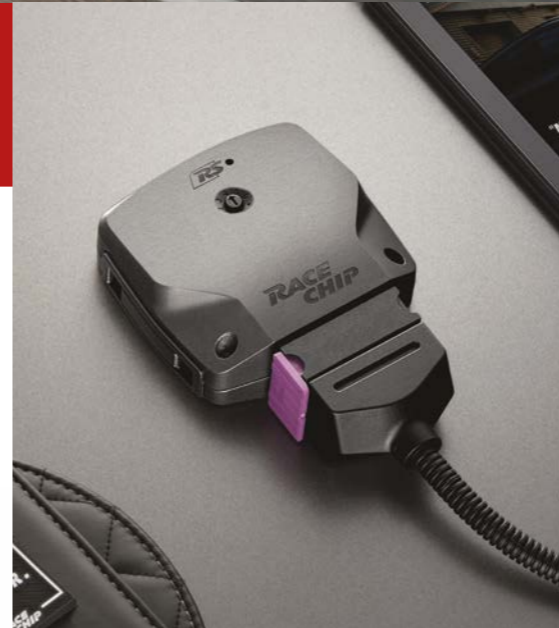

## XLR System & Interface





Golf Mk5  
Cat-Back Exhaust System



Golf Mk4  
Cat-Back Exhaust System



Cast Hi-Flow  
Downpipe Options



# MILLTEK

MORE INFO:



Founded in 1983 by a true car enthusiast, **Milltek Sport** has grown to become one of the leading manufacturers of performance exhaust systems for a continually growing range of vehicles. With headquarters in the UK and a development/testing centre at the iconic Nürburgring, Germany, Milltek designs, develops and tests its range of exhaust systems in-house using state-of-the-art equipment.

Golf Mk7 'Valved'  
Cat-Back Exhaust System

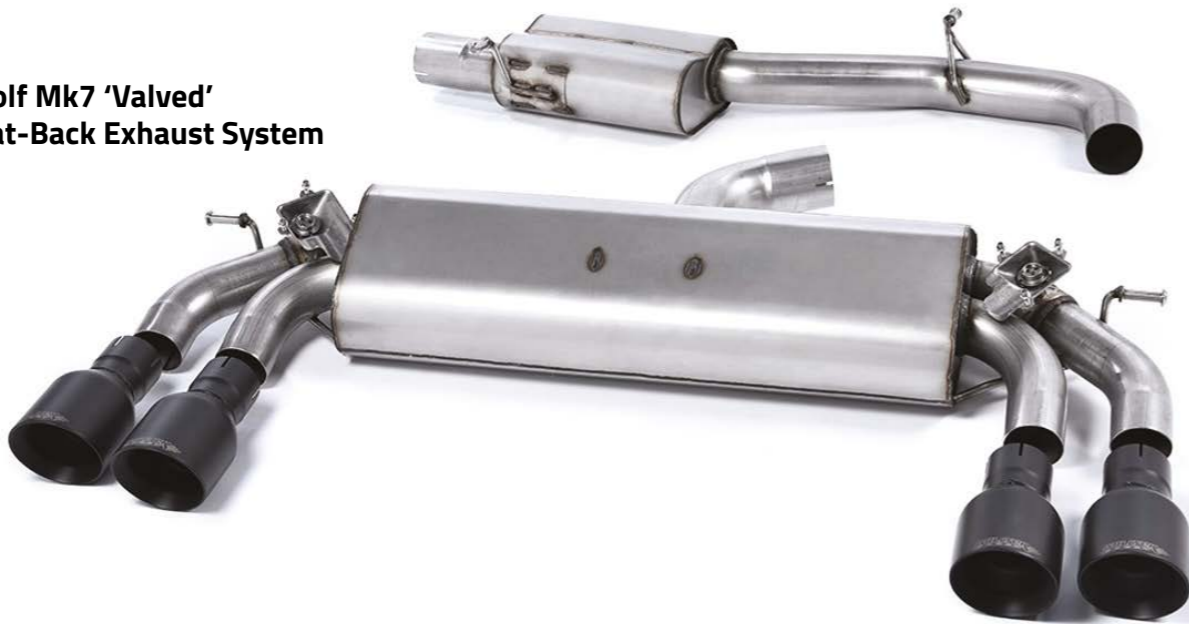



Golf Mk5 Cat-Back Exhaust System



Golf Mk7 GTi Cat-Back Exhaust System



Golf Mk7 R Downpipe and Cat/Decat



MORE INFO:



Since 1992, **Scorpion** has been designing, developing and manufacturing stainless steel performance exhausts in the heart of Derbyshire, UK. Focusing on light weight, combined with detailed workmanship and quality finish of each component part – all backed up by a dedicated R&D department where performance, reliability and acoustics are constantly tested and refined. Scorpion has also been technical partners with championship-winning motorsport teams since the early '90s.



Golf Mk7 'Race' Cat-Back Exhaust System



Anti-Lift Kit

Upper Engine Mount Insert Kit



Jack Pad Adapter



MORE INFO:



Spawned from EPTG Ltd (European Polyurethane Technologies Group) which was founded in the UK in 1996, Powerflex operates in a self-contained state-of-the-art factory, manufacturing everything in-house. Powerflex combines wide experience in automotive suspension and chassis systems with advanced polyurethane manufacturing techniques to develop a wide range of high performance automotive polyurethane components.

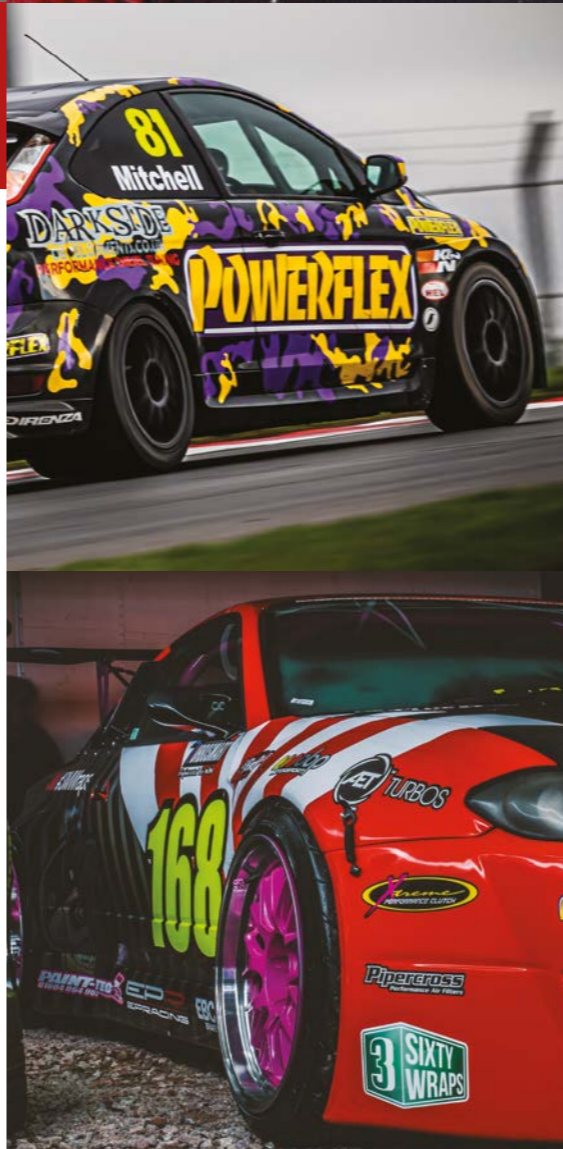



Height-Adjustable Spring Kit



**MORE INFO:**  
(for non-VW Audi-Group marques,  
please contact us directly)



For many years, **KW automotive GmbH** has been synonymous as the epitome of premium products in car tuning and automobile refinement. KW offers its customers the largest suspension programme worldwide. The entire assortment – from springs to coilover suspension systems – is unsurpassed on the market.



V1 Coilover Kit



V3 Coilover Kit





Golf Mk7 R/GTi X Coilovers



Golf Mk7 R Lowering Springs



**MORE INFO:**  
(for non-VW Audi-Group marques,  
please contact us directly)



ST Suspensions offers application-specific adjustable lowering springs, the perfect range of options for wheel spacers, complete sport suspension sets and a range of coilovers all at an unmatched value. The best part: all ST suspensions products are manufactured with legendary KW quality!



Modular 'DZX' Wheel Spacers



Mk4 SEAT Ibiza Sport Shocks



MQB Front Strut Top Mount Kit



Mk7 Golf B14 Coilover Kit



6C/6R Polo B14 Coilover Kit



Mk4 Golf R32 B8 Front Damper



**MORE INFO:**  
(for non-VW Audi-Group marques,  
please contact us directly)



For over 70 years, **BILSTEIN** has been realising the perfect driving behaviour and building the perfect shock absorbers. Even in a world whose pace is rapidly increasing, the German brand always aspires to be 'WAY AHEAD' – excelling both on road and track. Boasting a wide range of products to suit all vehicles and driving dynamics.

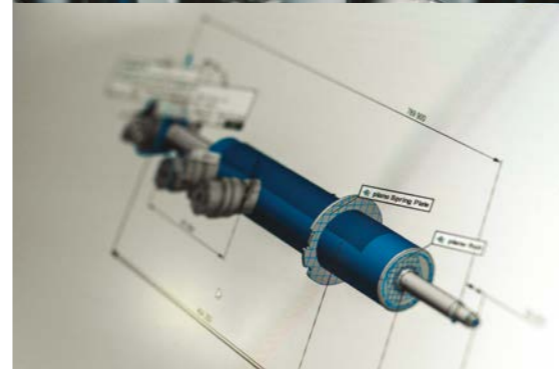



**MORE INFO:**  
(for non-VW Audi-Group marques,  
please contact us directly)



Forge Motorsport was founded in 1996 with the simple ideals of innovation, clever design, and manufacturing to the highest quality. Its history and heritage allows it to be preferred supplier and technical partner to the likes of BTCC, Mini Challenge and also the leading names and race teams in the world of motorsport including: F1, WRC, Rally X, and Le Mans. With Forge Motorsport, you are investing in peace of mind and the knowledge that true business integrity and care does actually exist.

**Performance Intake Kit**



**MQB Race Intercooler Kit**



**008 Diverter Valve**



**Hubcentric Wheel Spacer Kit**



Mk7 Golf R Sintered Performance Clutch Kit

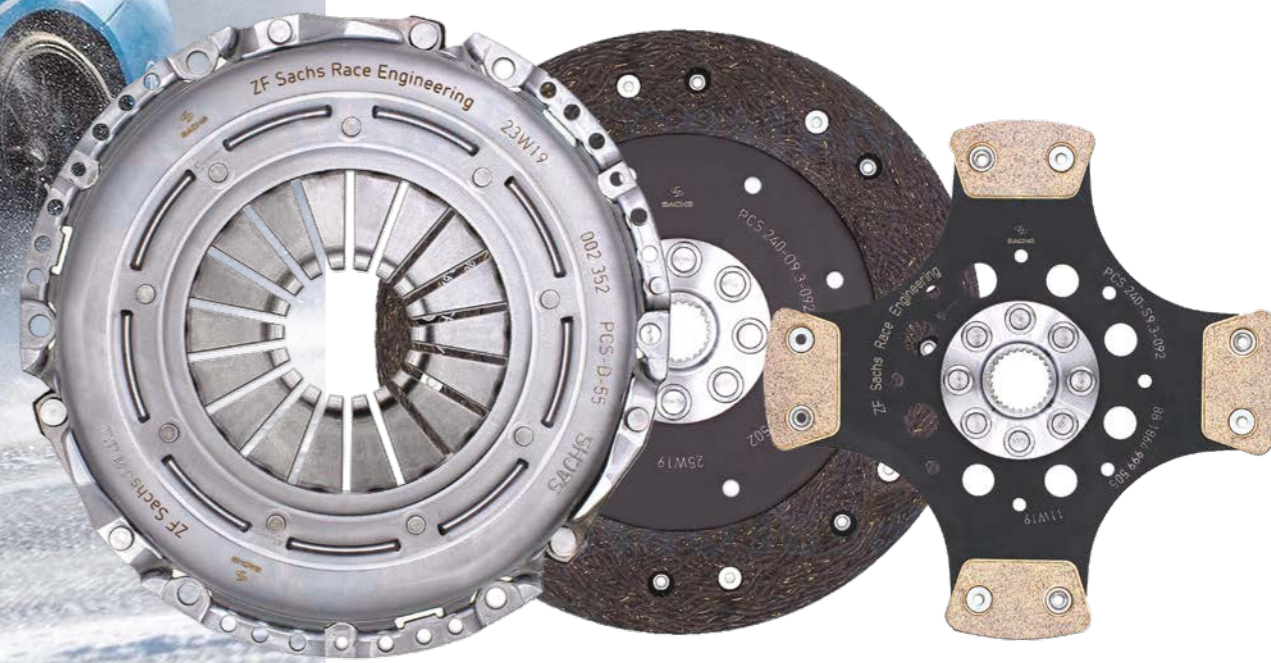

**MORE INFO:**  
(for non-VW Audi-Group marques, please contact us directly)



Performance clutch kits from **ZF SACHS** hold more transmittable torque and more stability, longer life and superior thermal resistance – advantages that are of great value not only to highly tuned vehicles but also in motorsports. Every SACHS Performance clutch is a product of the concentrated expertise obtained from many years of working in the motorsports industry. The extensive expertise gained on the toughest race tracks in the world has been directly applied to the development of the SACHS Performance clutches.



Mk4/5/6 Golf Release Bearing



Mk7 Golf R Performance Clutch Kit



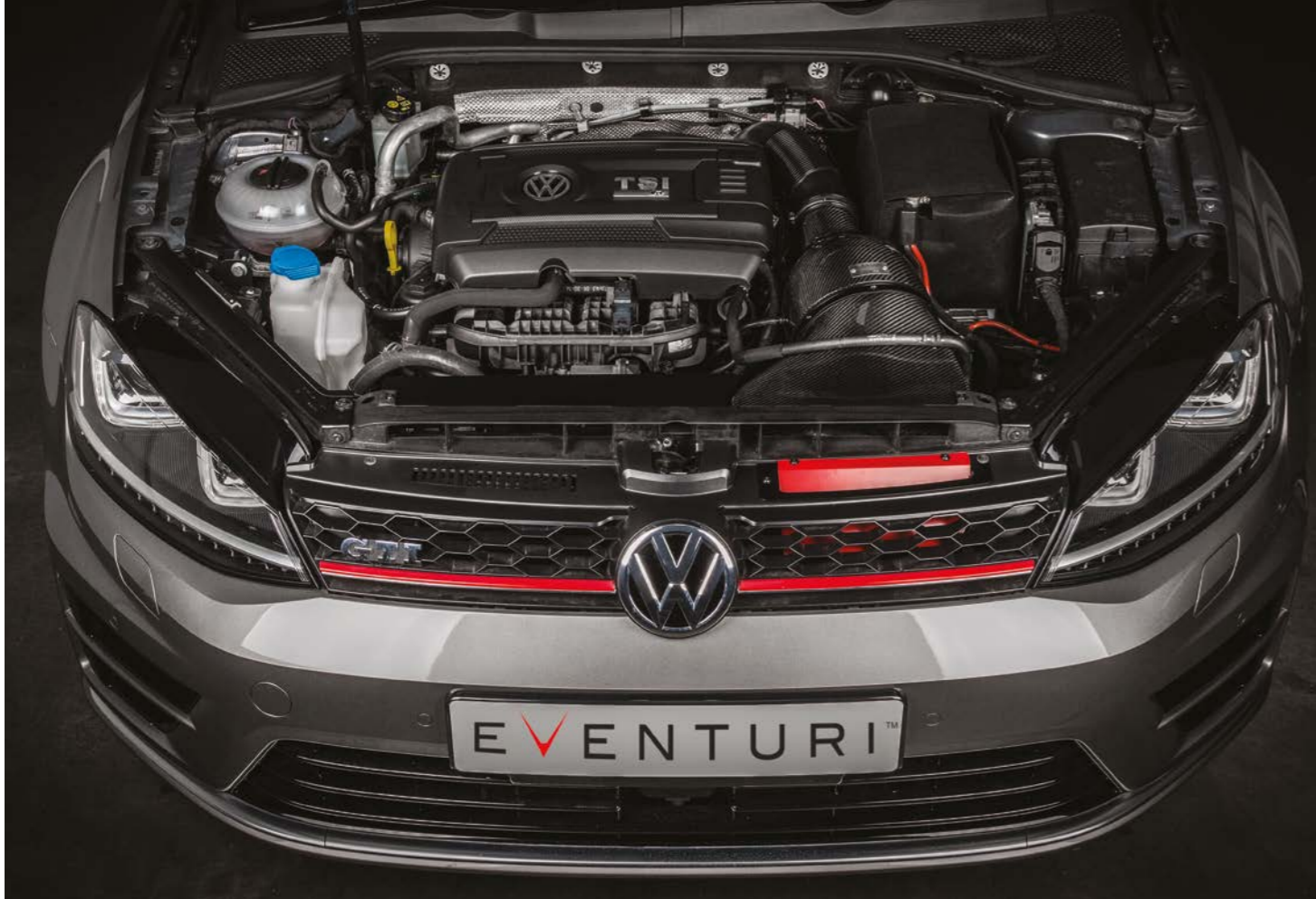

**Audi S1 Carbon Fibre Intake System**



**MBQ Carbon Fibre Intake System**



**Audi RS3 Carbon Fibre Turbo Inlet**



**EVENTURI™**

**MORE INFO:**  
(for non-VW Audi-Group marques,  
please contact us directly)



Formed by a team of engineers with a background in aeronautics and tuning, **Eventuri** set out to re-write the book and set new benchmarks in intake design and technology – engineering systems which provide real gains. Utilising cutting-edge design and manufacturing processes and only the most effective materials, the firm is proud to be raising the bar and creating intake systems which are setting a new standard and genuinely improve the performance of your vehicle.

**Audi RS6 Carbon Fibre Intake System**





MORE INFO: ➔



KONI is the premier manufacturer of performance and adjustable shock absorbers in the world. KONI shocks are made from the highest quality raw materials and machined to the highest tolerances. This quality is represented not only by KONI's long heritage in motorsports but also by the diversity of shock absorber solutions it offers. As well as car and racing dampers, KONI also produces shock absorber solutions for cars, busses, trucks, trailers, trains and even defence and industrial applications.



Sport Suspension Kit



STRT Suspension Kit



Special Active Damper Kit

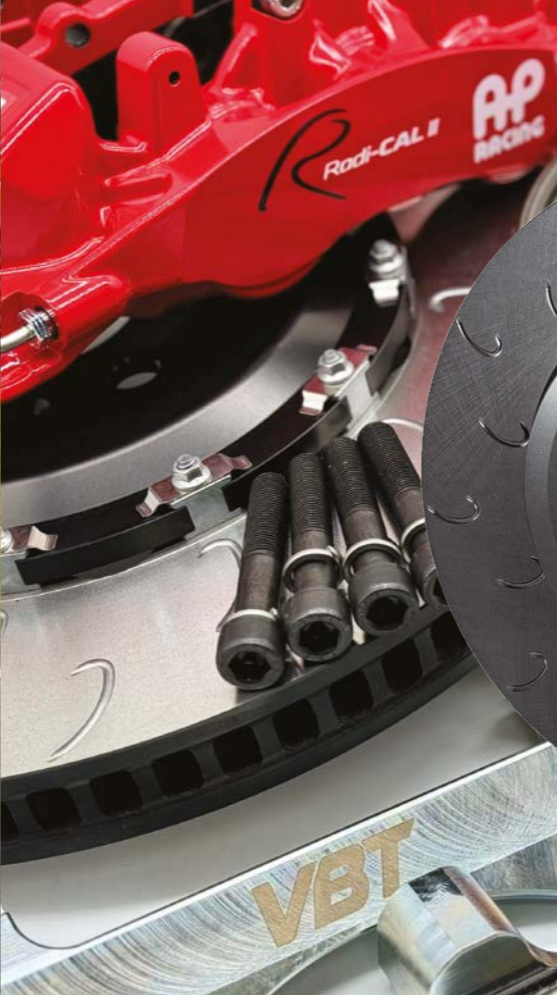

Hooked 340mm Front Brake Discs



**MORE INFO:**  
(for non-VW Audi-Group marques,  
please contact us directly)



Why **VBT**? First and foremost: pure and undiluted performance; if it doesn't work, it doesn't get supplied, however pretty it might look. The fact that VBT doesn't do anything except performance brake kits means that there are no other distractions, and that it is perfectly placed to devise uncompromising kits that fit perfectly and perform in an exemplary manner. VBT builds brakes for performance applications, specifically for those that intend to drive their cars in the manner in which they were intended, hence why its kits are constructed from some of the most advanced materials around and have garnered praise from professional drivers both in cup cars and endurance racers alike.



MBQ Front Brake Kit



Audi TTRS 2-Piece Front Discs



**Golf Mk3 GTi  
Front Big Brake Kit**

**Audi RS3  
Front Brake Discs**



**RoadRace  
Super DOT4 Brake Fluid**



**MORE INFO:**  
(for non-VW Audi-Group marques,  
please contact us directly)



Tarox is the manufacturer of high-performance brake upgrades. Founded in 1976, Tarox produces a wide selection of braking products, from performance discs and pads to bespoke calipers and systems. All Tarox discs and calipers are designed and manufactured in its factory in Northern Italy. This in-house approach ensures the very maximum in performance and quality. Every Tarox disc is constructed using the highest quality casts and steel billets before being heat treated and balanced by hand for the smoothest possible surface.

**Strada  
Front Brake Pads**





Mk3 Scirocco Rear Silencer



Mk7 GTi Rear Silencer Delete



Mk7 R Non-Res Cat-Back System



MORE INFO: 



Remus' mission is to do everything it can to get the maximum possible out of a vehicle. It accomplishes this by creating unique innovations in the premium sport exhausts system sector, producing products more sustainably and with a global-thinking team. The brand defines itself by the sound of its products, in which it put its heart and soul into, by following its own path and by putting words into actions. Break the silence with Remus!





MQB Performance Intercooler Kit



1.8 20V Turbo Intake Pipe



MQB Oversized Muffler Delete



**MORE INFO:**  
(for non-VW Audi-Group marques,  
please contact us directly)



Established in 2007, **DO88** is a Swedish performance engine parts company specialising in the development of intercoolers, silicone hose kits, alloy radiators and more. All DO88 products are designed and tested in-house, with the object of achieving the maximum available performance and quality. When tested directly against other brands, DO88 products excel in terms of performance without compromise, as well as offering great value for money.





1.8 20v 'Seat Sport Style' Intercooler



**MORE INFO:**  
(for non-VW Audi-Group marques,  
please contact us directly)



Over the last few decades, **AIRTEC Motorsport** has evolved into one of the leading performance parts manufacturers in the UK, renowned for its range of high-performance intercooler upgrades for a countless number of applications. Located in Essex, AIRTEC Motorsport HQ's in-house development team strives to make the best parts possible at a price that is competitive. AIRTEC's strong passion for both design and performance shines through in every product it creates.

Intercooler & Big Boost Pipe Package



2.0 TFSI Stage 2 Intercooler

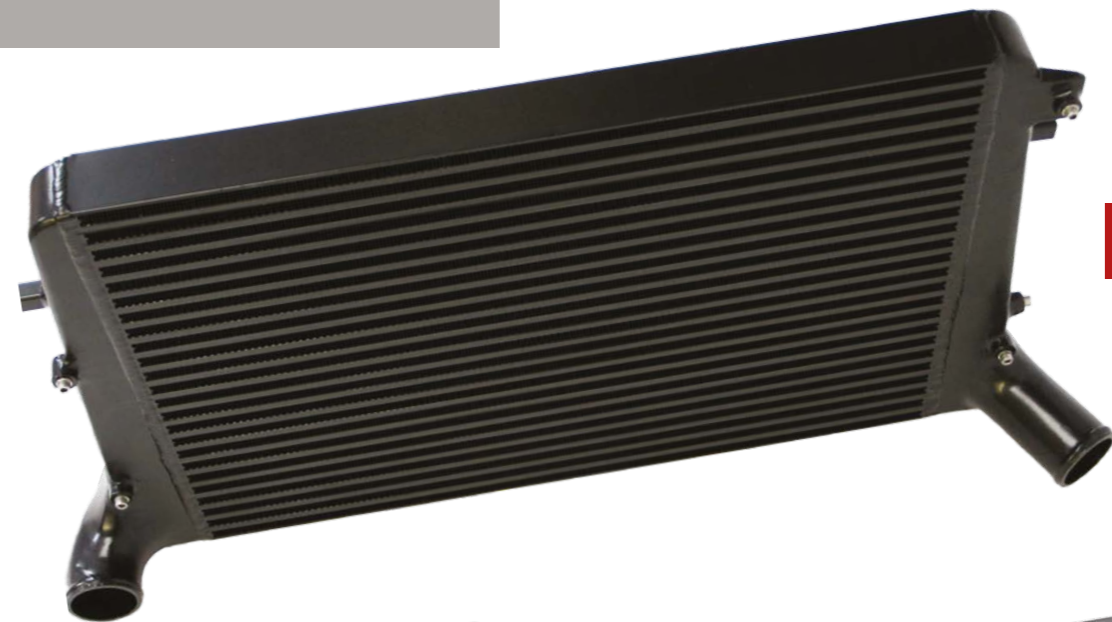

Audi S1 Stage 2 Intercooler





2.0 TSI Jetstream Induction Kit with Intake Hose And Turbo Elbow



# RAMAIR

**MORE INFO:**  
(for non-VW Audi-Group marques,  
please contact us directly)



With a motorsport heritage stretching back to 1981, RamAir is one of the world's leading air filtration specialists. Run by a bunch of dedicated car enthusiasts, RamAir's products have been extremely well received by the VW Group community. From stunning show-car engine bays, to hard-worked track weapons, you'll find the RamAir brand everywhere.



MQB Jetstream Induction Kit with intake Hose



A1/S1/Ibiza/Polo Jetstream Induction Kit



**AKRAPOVIČ**

**MORE INFO:**  
(for non-VW Audi-Group marques,  
please contact us directly)



When it comes to exhaust systems, **Akrapovič** excels in its improved performance, unmistakable sound, innovative design and construction, craftsmanship and durability. The company's state-of-the-art factories in Slovenia also include an in-house titanium foundry and metallurgical laboratory. Akrapovič has over 1800 employees and sells its products in over 80 countries. Racing has always been in the company's DNA, offering technical services and support to MotoGP, WorldSBK, MXGP, IMSA WTSC, and other international series.



**Mk7 GTi 'Slip On Line'  
Titanium Exhaust System**



**Audi RS6 'Evolution Line'  
Titanium Exhaust System**



**Audi RS3 'Evolution Line'  
Titanium Exhaust System**



**MORE INFO:**  
(for non-VW Audi-Group marques,  
please contact us directly)



GFB ('Go Fast Bits') is an Australian company manufacturing an exemplary range of innovative and high-quality automotive products that give your vehicle the performance, sound and look you desire. Its parts are meticulously designed, tested, and crafted from the highest-grade materials in its own state-of-the-art CNC manufacturing facility. Keeping the design and production processes in-house affords total quality control of its products from start to finish. GFB's philosophy is to produce exceptional automotive products that are built with the same precision, machining quality, and reliability that is the foundation of its reputation.



**Lightweight  
Crank Pulley**



**DV+  
Diverter Valve**



**G Force II  
Boost Controllers**



**Audi TT Road & Track Coilover Kit**



**EDC Cancellation Kit**



**Golf Mk7 Road & Track Coilover Kit**



**MORE INFO:**  
(for non-VW Audi-Group marques,  
please contact us directly)



Öhlins has been a cornerstone of the motorsport, motorcycle, and automotive industries for over 45 years. Since day one, its focus has been on delivering high-quality products, service, and support – from the MotoGP circuit to national and local racing events – in over 50 distributing countries. Öhlins supplies the aftermarket, OEM partners, and teams with high-end suspension technology, and strives to exceed the expectations of its customers around the world.

**Audi S3 8V Road & Track Suspension**





TTE420 Hybrid 2.0TSI Turbocharger

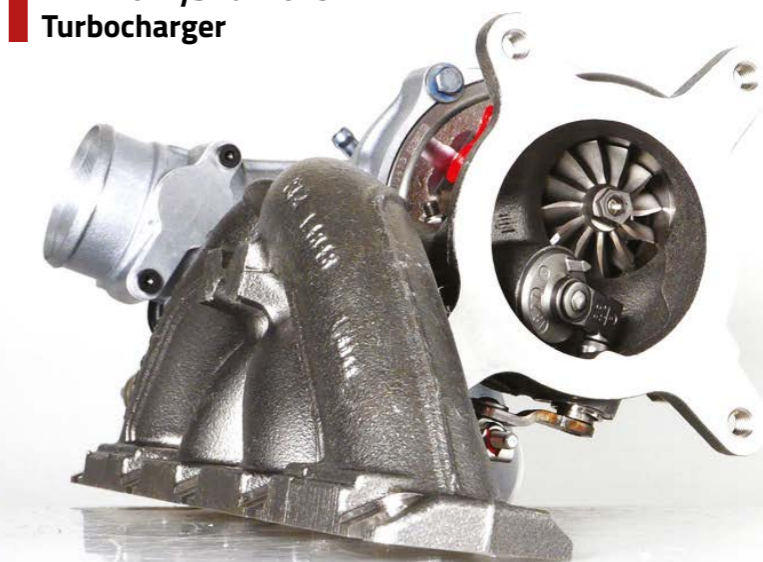

**TheTurboEngineers**

**MORE INFO:**  
(for non-VW Audi-Group marques, please contact us directly)



The Turbo Engineers (TTE) is a dynamic and highly innovative upgraded turbocharger engineering company specialising in the production of motorsport turbochargers of the highest quality and efficiency for the automotive sector. It focuses on prototype design from concept to completion, with most of the work done in-house to meet its own extremely high standards. In doing so, every component is optimised for the greatest possible reliability and longevity.

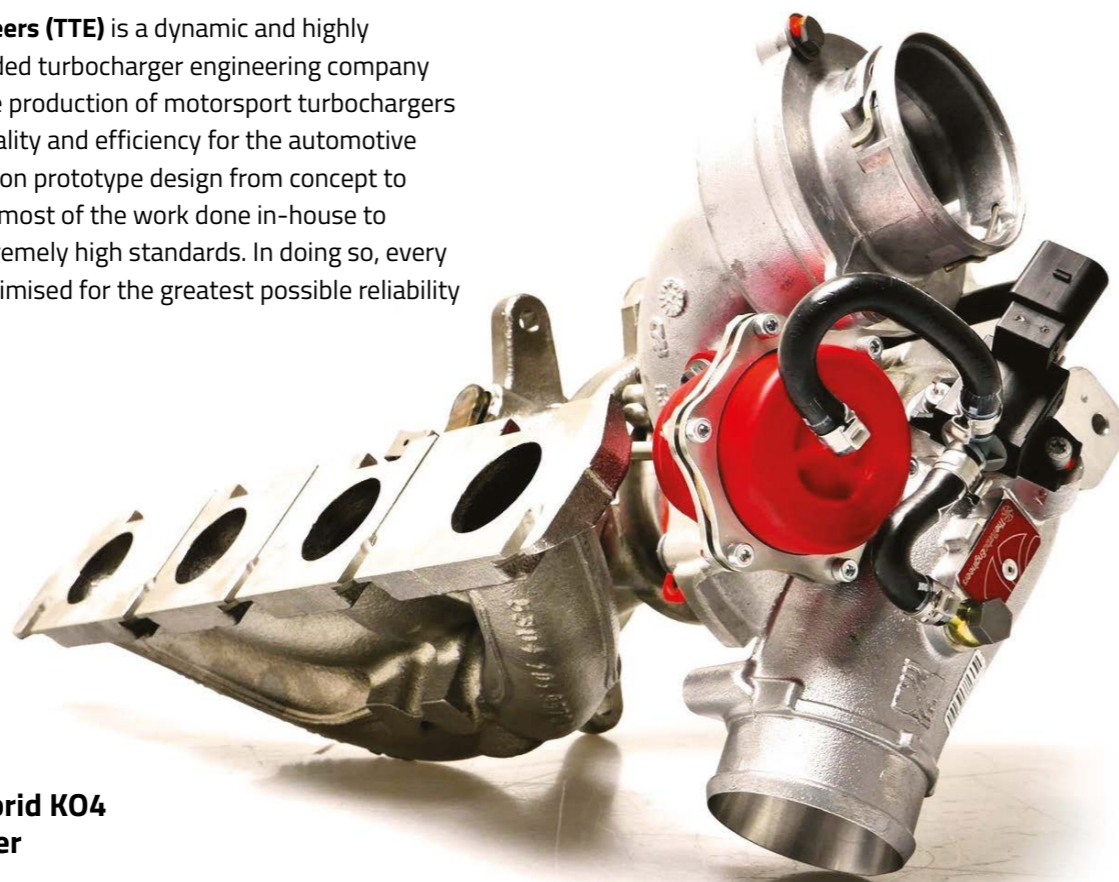

TTE420 Hybrid KO4 Turbocharger



TTE480 Hybrid KO4 Turbocharger



3.5" Velocity Stack Air Intake System



Evo Intake Kit



Turbo Muffler Delete



**MORE INFO:**  
(for non-VW Audi-Group marques,  
please contact us directly)



CTS Turbo is an industry-leading performance parts manufacturer. With over 10 years in VW and Audi performance, it's since mastered its craft and has expanded across multiple makes and models. CTS Turbo's mission is to make horsepower affordable, offering bolt-on solutions for everything from the DIY garage build to the clean room-built dyno queen, and everything in-between.



Turbo Inlet Elbow Pipe





**MORE INFO:**  
(for non-VW Audi-Group marques,  
please contact us directly)



Whiteline boasts a worldwide reputation as a leading manufacturer of replacement, enhancement and performance suspension components that deliver significant gains in vehicle balance, steering precision, grip levels and outright driving performance. Consisting of adjustable anti-roll bars, lowering springs, grip series handling kits, chassis bracing, alignment products and chassis control bushing kits, Whiteline products provide automotive workshops, tuners, enthusiasts and racers with innovative solutions to suspension and handling problems while delivering proven performance and problem solving outcomes for many of the world's vehicle platforms.

**20mm Rear  
Anti Roll Bar**



**24mm Rear  
Anti Roll Bar**



**Front Sway Bar  
Link Assembly**



**Anti Lift  
Kit**





Aroma Range & Aqua Coat Rinse Aid



MORE INFO:



Established in 1999, **Auto Finesse** started its journey into car care as a man, van, and a passion for clean, shiny cars. Channelling 25 years of hands-on experience into everything it does, today, Auto Finesse manages each step of the process in house, putting quality, value and performance at the heart of everything it creates.

Master Machine Polishing Kit



Aqua Deluxe Drying Towel XL



Arch Blaster



FSS50  
Fire Extinguisher



MORE INFO:



The Fire Safety Stick is a new, innovative fire extinguisher which takes the guesswork out of using a fire extinguisher. It requires less knowledge or training for the everyday person. An extinguisher which works on five classes of fire, meaning less margin for error if accidentally choosing the incorrect traditional extinguisher, and making the fire worse in a high-stress situation. Ideal for storing in your car in case the worst happens. Best of all: it leaves no mess and no residue behind!



FSS100  
Fire Extinguisher





Universal Rubber Neck Filter



**MORE INFO:**  
(for non-VW Audi-Group marques,  
please contact us directly)



For over 40 years, **Pipercross** has endeavoured to develop the best air filters on the market, in both performance and filtration. Opting to use foam for its greater dirt retention capability while not restricting flow, which has allowed it to keep vehicles of all types performing their best throughout ownership. Manufacturing in the UK using high-quality parts, many of which are locally sourced, each filter is created by hand in a step-by-step process, ensuring the highest level of quality control at every stage of this process.



Panel Filters



Performance Panel Filter

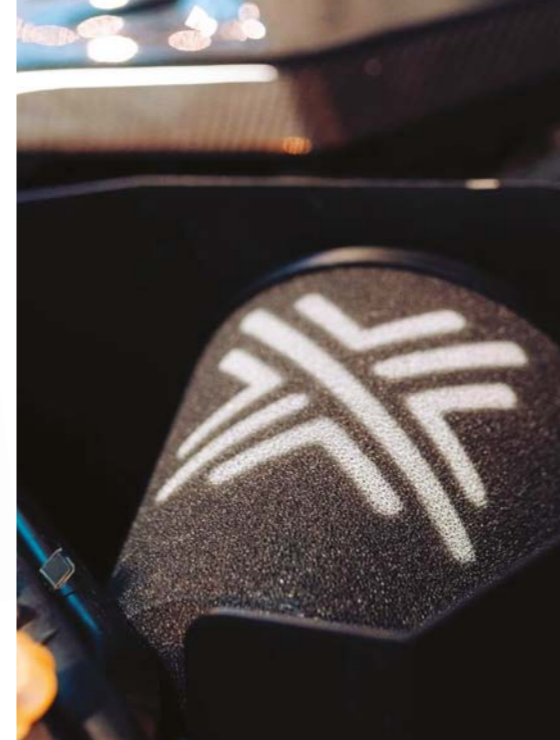



## OUR TEAM

At the heart of Awesome lies an unrivalled and experienced team of dedicated and passionate individuals. Together, we're one Awesome family.



**MARK ASH**  
Managing Director



**JOHN GLOVER**  
Operations Director



**SIMON BARNES**  
Technical Director



**ANDREA ASHTON**  
Finance Director

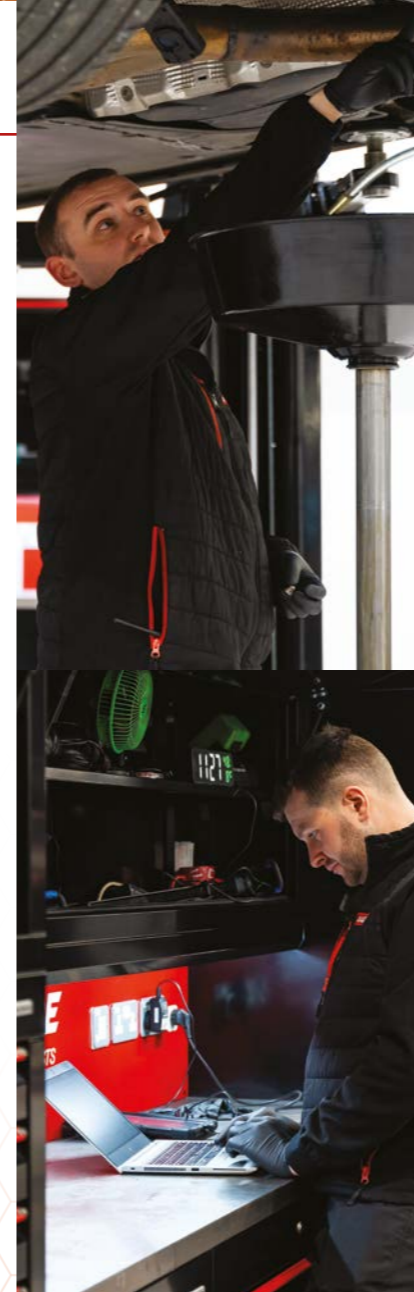

## SALES



**STEPHEN**  
Sales Office Manager



**AL**  
Product & Trade Manager



**LEWIS**  
Sales Advisor



**CHARLOTTE**  
Sales Advisor

## WORKSHOP



**LISA**  
Service Manager



**ANITA**  
Service Advisor



**AL**  
Technician



**GREG**  
Technician



**JAMIE**  
Technician



**ROB**  
Technician

## WAREHOUSE



**MIKE**  
Warehouse Manager



**MARK**  
Warehouse Operative



**WAYNE**  
Warehouse Operative

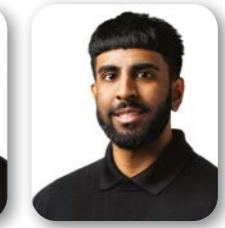

**REECE**  
Dispatch & Returns



**OWEN**  
Dispatch & Returns



**LIAM**  
Dispatch & Returns



**KAYLEIGH**  
Accounts Assistant



**STEPHEN**  
Site Supervisor



**MATT**  
Customer Service



**SCAN HERE**  
**TO FLY AROUND**  
**OUR WORKSHOP!**



 Awesome GTI Limited

 /AwesomeGTI

 @Awesome\_GTI

 @AwesomeGTI

 Awesome Cars



**AWESOME®**

 **Awesome Ltd**  
Unit 1 Siemens Road, Northbank Industrial Park,  
Irlam, Manchester M44 5AH, UK

 +44 (0) 161 776 0777

 sales@awesomegti.com

 awesomegti.com

Copyright©2024 Awesome Ltd. All Rights Reserved. E&OE